

# Dry and Clean Drilling in all Tiles



**NEW!** Self-cooling diamond drill bits  
and cutters for drills and angle grinders.



**BOSCH**

Invented for life

# **Dry drilling** even in the hardest tiles

**The innovative self-cooling and powerful diamond dry drill bits and cutters for drills and angle grinders enable clean drilling without water in all types of tile.**

Hard tiles are increasingly being used in interiors, not only for floors, but also for walls in kitchens and bathrooms. Until now, water cooling always had to be used when drilling holes in very hard tiles, in order to prevent the build-up of heat from damaging the diamonds. This usually meant that extra dirt was caused by the moisture and drilling dust, and it often resulted in time-consuming cleaning after drilling. Bosch is now putting an end to this!

The new diamond dry drill bits and cutters make drilling in hard tiles easier, cleaner and more efficient. And they offer a very long lifetime and very high drilling performance.

The range covers all diameters required for plumbing and tiling work:

- ▶ **Easy Dry diamond drill bits in diameters of 6 to 14 mm for cordless screwdrivers and drills.**
- ▶ **Dry Speed diamond cutters in diameters of 14 to 83 mm for angle grinders.**

With these self-cooling diamond dry drill bits and cutters, Bosch is offering specialist retailers a true innovation in the diamond tools segment. For the highest requirements, for more sales and for satisfied tradesmen.

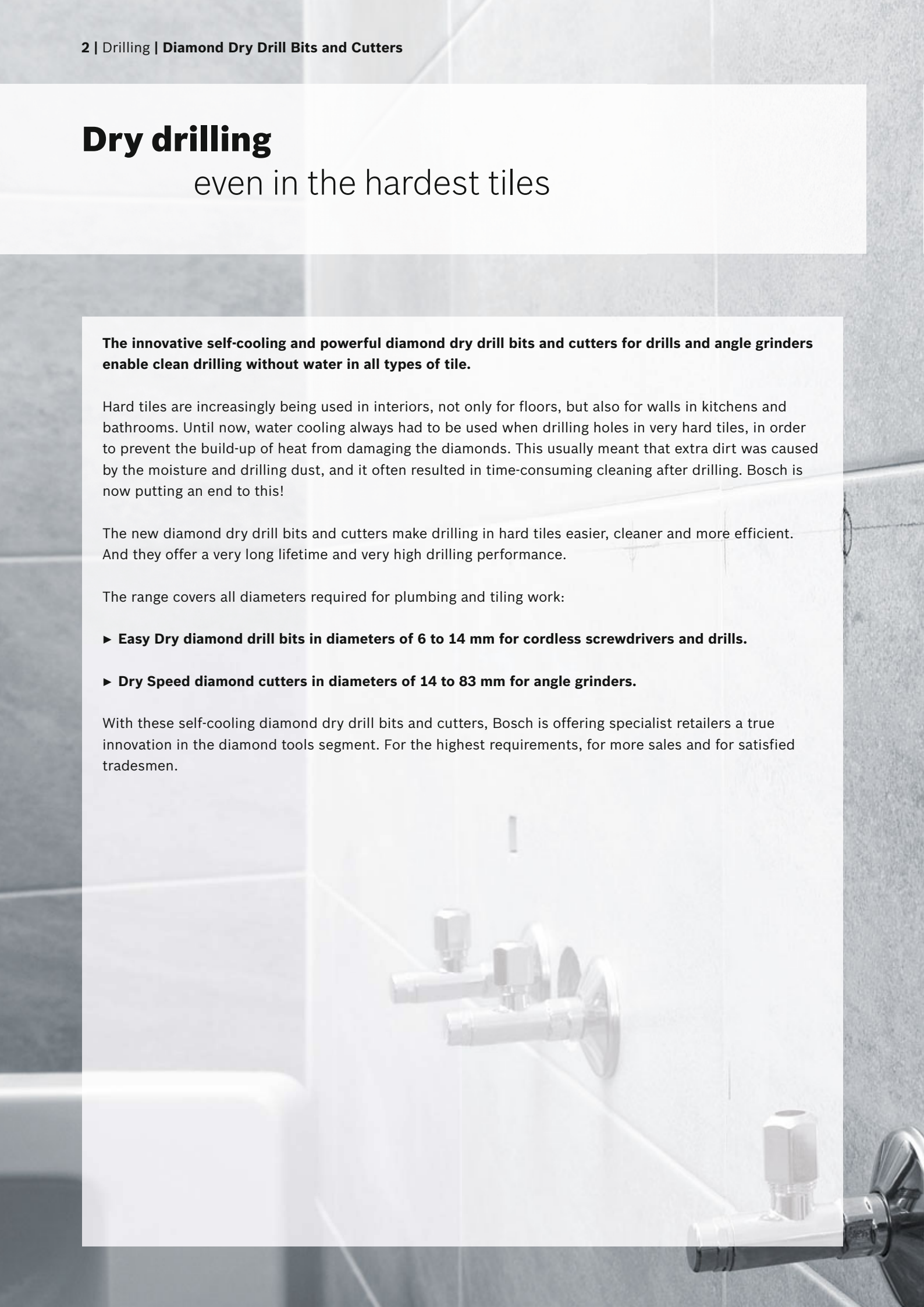

# Contents

<b>Easy Dry diamond drill bits</b>	for cordless screwdrivers and drills	<b>4</b>
<b>Dry Speed diamond cutters</b>	for angle grinders	<b>8</b>
<b>Range overview</b>	Easy Dry diamond drill bits	<b>10</b>
	Dry Speed diamond cutters	<b>12</b>
	Diamond dry drill bits and router bits	<b>14</b>
	Diamond wet drill bits	<b>16</b>
	Diamond cutting discs	<b>19</b>
<b>Work safety</b>		<b>22</b>

# Easy Dry diamond drill bits: long lifetime, easy handling

The strength of the new Easy Dry diamond drill bits lies in their easy handling and their very long lifetime despite dry use. This minimises time-consuming preparatory work, which is common with wet drilling.

- ▶ **No more installing – No need for water bottle and centring aid**
- ▶ **No longer necessary to remove the piece of drilled material**
- ▶ **No time-consuming cleaning of the work area after drilling**
- ▶ **Self-sealing drill bit; coolant does not leak**

## Double the lifetime

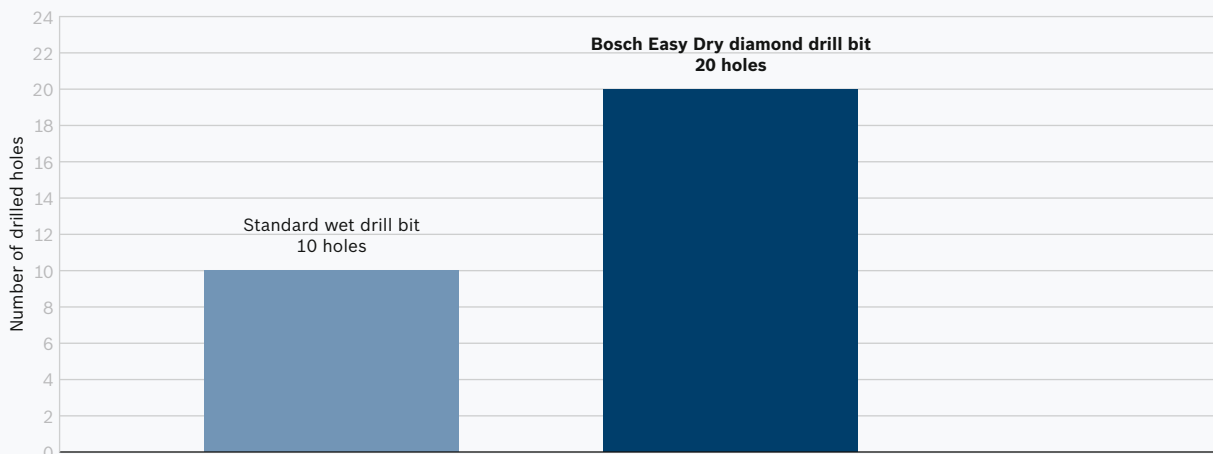

Tests by Bosch with 6-mm diamond drill bit in fine stoneware.





# Innovative self-cooling for clean drilling

The drill bit's diamonds are cooled by a vegetable oil based coolant inside the drill bit shank. This coolant flows through the drill bit tip during drilling and cools the diamonds.

The coolant is released by the rotary motion of the drill bit and by the volume reduction in the bit body. The diamonds are effectively cooled during drilling. This prevents premature burn-up of the diamonds and increases the lifetime.

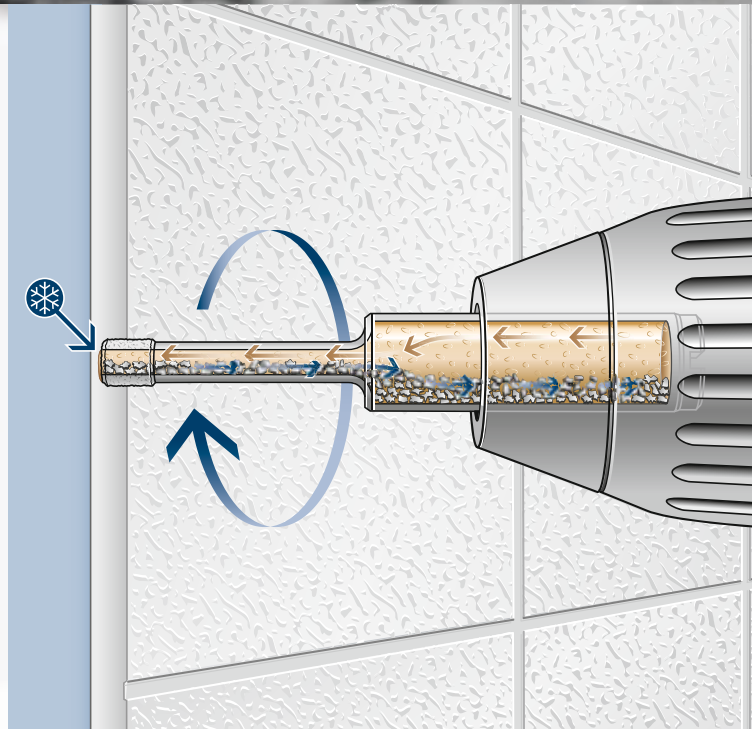

# Correct handling

## for the optimum work result

Crucial to working with diamond dry drill bits effectively is that they are handled correctly. It is advisable to apply the drill bit at a slightly inclined angle. After starting to drill the hole, the drill bit is gradually brought into a perpendicular position. The fast drilling rate is enhanced by performing slight circular motions during drilling.

The waste material no longer has to be removed, when using the diamond drill bits with diameters of 6 to 14 mm, because it is used to stop the coolant supply. In every subsequent drilling application, pressure forces the waste material into the inside of the drill bit and new oil for cooling is fed to the drill bit tip.

To ensure the long lifetime, it is important to make sure that only tiles are drilled. Appropriately adapted drill bits should be used to drill holes in other materials.

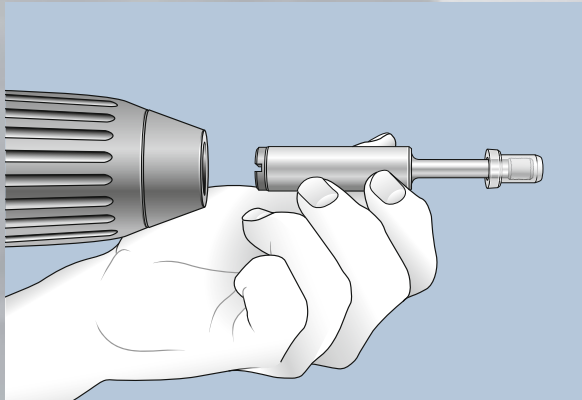

Insert the drill bit into the toolholder.

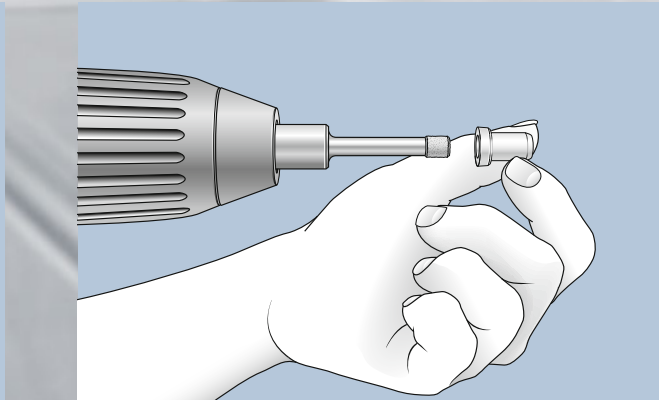

Remove the stopper.



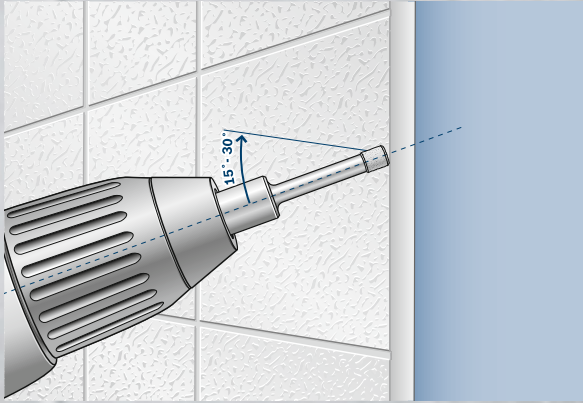

Apply the drill bit at an incline to start drilling (angle of 15° to 30°) and gradually straighten it up.

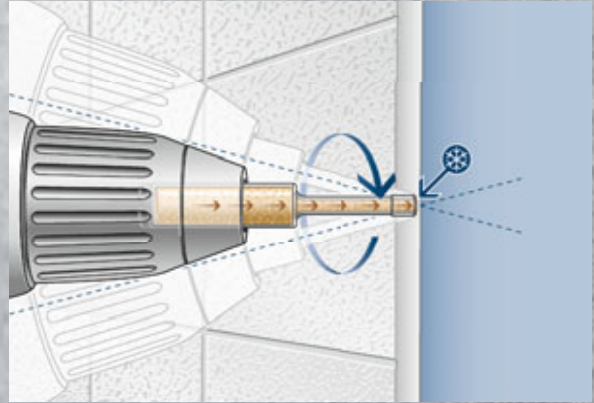

Drill through the tile using slight circular motion.



# Dry Speed diamond cutters:

for the highest drilling speed in



The diamond dry cutters with M14 shank for angle grinders with a maximum speed of 11,000 rpm achieve a considerably higher cutting speed and have a longer lifetime than comparable wet drilling products. Outstanding effect:

- **More holes can be drilled in the shortest time and with less effort.**

## Ten times longer lifetime

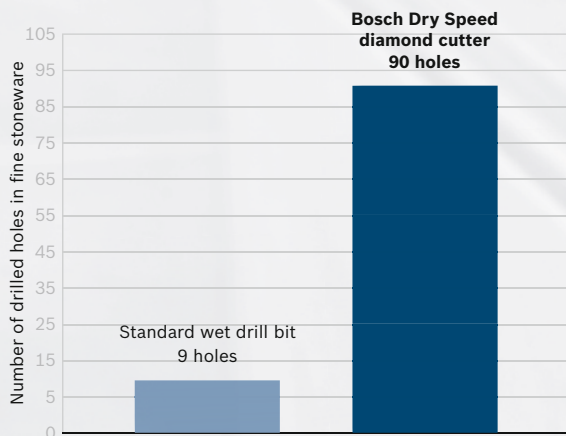

Tests by Bosch with 40-mm diamond cutter in fine stoneware.

## Considerably higher drilling speed

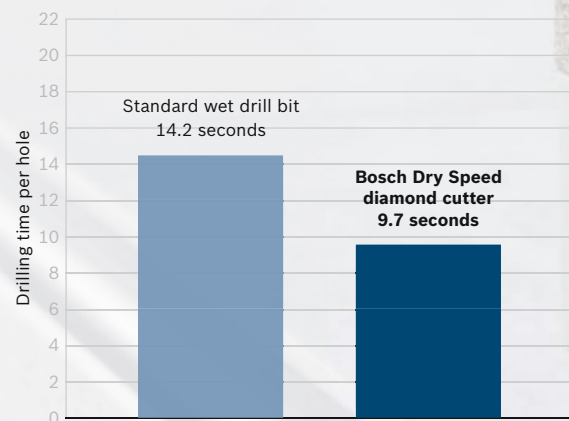

Tests by Bosch with 40-mm diamond cutter in fine stoneware.





all hard tiles

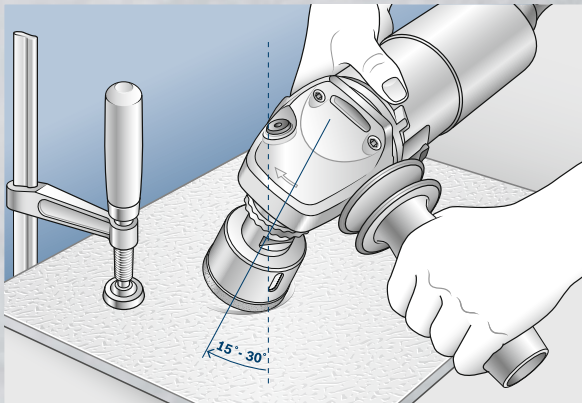

Apply the cutter at an incline to start drilling (angle of 15° to 30°) and gradually straighten it up.

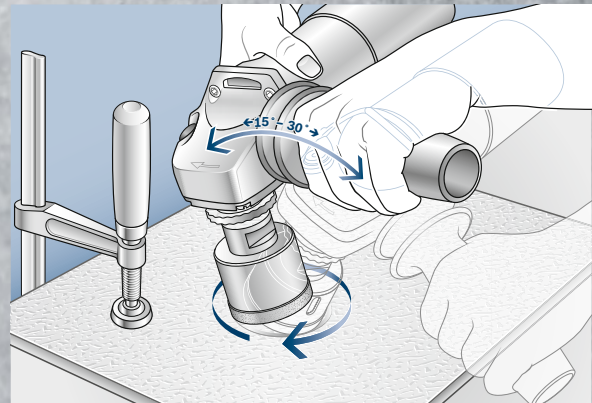

Drill through the tile or natural stone slab with slight circular motion.



# Diamond dry drill bits



Easy Dry diamond drill bits for outstanding drilling results

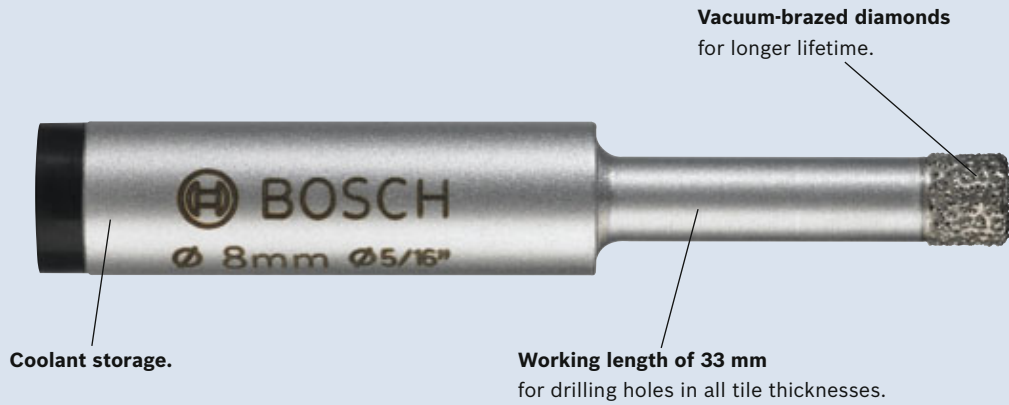

## Diamond drill bits Easy Dry

best Ceramic



**Suitable for** soft wall tiles through to very hard floor tiles such as fine stoneware. For use in cordless screwdrivers and drills with 13 mm chuck.

**Note:** Drill without impact. Optimum speed: 1500 rpm.



	Diameter (D) mm	Diameter (D) Inch	Working length (L1) mm	Part number	Packaging type	Sales package quantity	Despatch package quantity	Barcode 3165140...
<b>Product properties</b>				<b>Ordering information</b>				
6	15/64		33	<b>2 608 587 139</b>	P1p	1	1	577915
7	9/32		33	<b>2 608 587 140</b>	P1p	1	1	577922
8	5/16		33	<b>2 608 587 141</b>	P1p	1	1	577939
10	25/64		33	<b>2 608 587 142</b>	P1p	1	1	577946
12	15/32		33	<b>2 608 587 143</b>	P1p	1	1	577953
14	9/16		33	<b>2 608 587 144</b>	P1p	1	1	577960

Order quantity for a part number in pieces = Sales package quantity x despatch package quantity  
 Order quantities that do not match the specified increments of the despatch package quantity (e.g. 5 -> 10 -> 15) are automatically rounded up to the next increment.

**Robust Line diamond drill bit set Easy Dry**

best  Ceramic



Set size A:  
156.5 x 69.5 x 21.5 mm

Product properties		Ordering information					
Diameter mm	Working length(s) mm	Part number	Packaging type	Sales package quantity	Despatch quantity	Barcode	3165140...
3-piece diamond drill bit set							
6	33	2 608 587 145	P1k	3	1	577977	
8							
10							

Order quantity for a part number in pieces = Sales package quantity x despatch package quantity  
Order quantities that do not match the specified increments of the despatch package quantity (e.g. 5 -> 10 -> 15) are automatically rounded up to the next increment.



**Dry Speed diamond cutters for considerably higher drilling speed and longer lifetime**

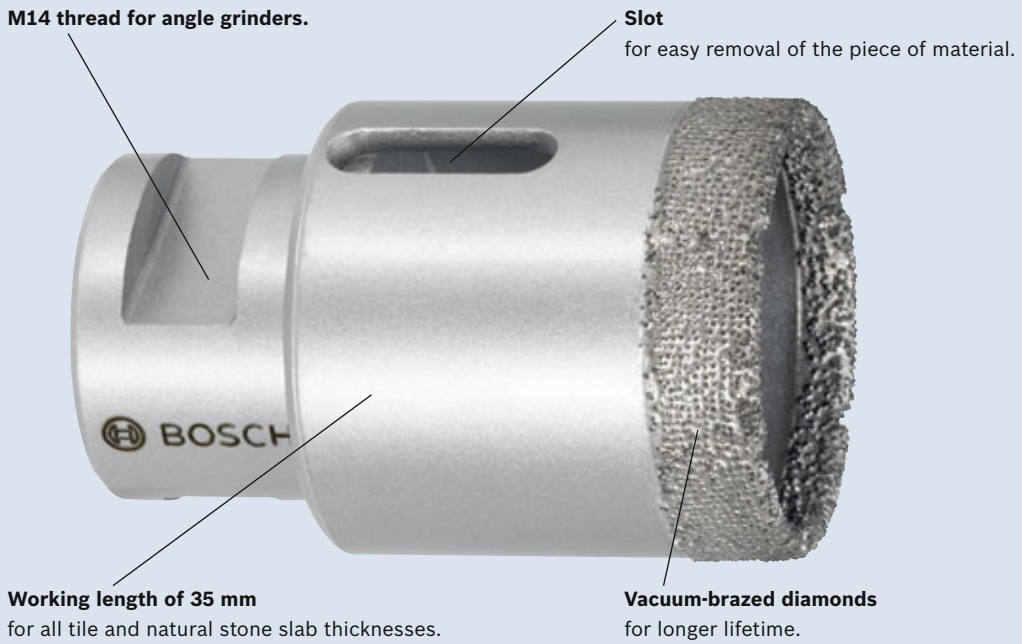

**Diamond cutters Dry Speed**

best Ceramic

**Suitable for** soft wall tiles through to very hard floor tiles and natural stone. For use on angle grinders.

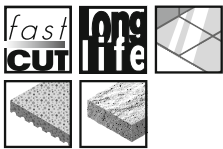

Diameter (D) mm	Diameter (D) Inch	Working length (L1) mm	Part number	Packaging type	Sales package quantity	Despatch package quantity	Barcode 3168140...
<b>Product properties</b>			<b>Ordering information</b>				
14	9/16	30	<b>2 608 587 113</b>	P1h	1	1	577656
16	5/8	30	<b>2 608 587 114</b>	P1h	1	1	577663
20	25/32	35	<b>2 608 587 115</b>	P1h	1	1	577670
22	7/8	35	<b>2 608 587 116</b>	P1h	1	1	577687
25	1	35	<b>2 608 587 117</b>	P1h	1	1	577694
27	1 1/16	35	<b>2 608 587 118</b>	P1h	1	1	577700
30	1 3/16	35	<b>2 608 587 119</b>	P1h	1	1	577717
32	1 1/4	35	<b>2 608 587 120</b>	P1h	1	1	577724
35	1 3/8	35	<b>2 608 587 121</b>	P1h	1	1	577731
38	1 1/2	35	<b>2 608 587 122</b>	P1h	1	1	577748
40	1 9/16	35	<b>2 608 587 123</b>	P1h	1	1	577755
45	1 49/64	35	<b>2 608 587 124</b>	P1h	1	1	577762
51	2	35	<b>2 608 587 125</b>	P1h	1	1	577779
55	2 11/64	35	<b>2 608 587 126</b>	P1h	1	1	577786
57	2 1/4	35	<b>2 608 587 127</b>	P1h	1	1	577793
60	2 3/8	35	<b>2 608 587 128</b>	P1h	1	1	577809

Order quantity for a part number in pieces = Sales package quantity x despatch package quantity  
 Order quantities that do not match the specified increments of the despatch package quantity (e.g. 5 -> 10 -> 15) are automatically rounded up to the next increment.



**Diamond cutters Dry Speed**

Diameter (D) mm		Diameter (D) Inch		Working length (L1) mm		Part number		Packaging type		Sales package quantity		Despatch package quantity		Barcode 3165140...	
Product properties				Ordering information											
65	2 9/16	35	<b>2 608 587 129</b>	P1h	1	1	577816								
67	2 5/8	35	<b>2 608 587 130</b>	P1h	1	1	577823								
68	2 11/16	35	<b>2 608 587 131</b>	P1h	1	1	577830								
70	2 3/4	35	<b>2 608 587 132</b>	P1h	1	1	577847								
75	2 61/64	35	<b>2 608 587 133</b>	P1h	1	1	577854								
80	3 5/32	35	<b>2 608 587 134</b>	P1h	1	1	577861								
83	3 1/4	35	<b>2 608 587 135</b>	P1h	1	1	577878								

**Diamond cutter set Dry Speed**

best of **Ceramic**

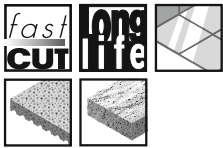

Diameter mm		Working length(s) mm		Part number		Packaging type		Sales package quantity		Despatch package quantity		Barcode 3165140...	
Product properties				Ordering information									



3-piece diamond cutter set

14	30	<b>2 608 587 136</b>	U0	3	1	577885							
25	35												
35													



4-piece diamond cutter set

25	35	<b>2 608 587 137</b>	U0	4	1	577892							
35													
45													
51													

Order quantity for a part number in pieces = Sales package quantity x despatch package quantity  
 Order quantities that do not match the specified increments of the despatch package quantity (e.g. 5 -> 10 -> 15) are automatically rounded up to the next increment.

# Diamond dry drill bits and router bits

## for GTR 18 V-LI and GTR 30 CE Professional

### Diamond drill bits Best for Ceramic

best  Ceramic

Appropriate for GTR 18 V-LI and GTR 30 CE Professional.

Suitable for soft wall tiles through to very hard floor tiles and natural stone.

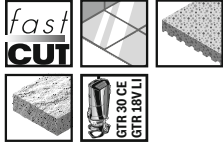

Product properties		Ordering information						
Diameter (D) mm	Diameter (D) Inch	Working length (L) mm	Part number	Packaging type	Sales package quantity	Despatch package quantity	Barcode 3165140...	
6	15/64	35	2 608 587 155	P1a	1	1	587686	
8	5/16	35	2 608 587 156	P1a	1	1	592734	
12	15/32	35	2 608 620 211	P1a	1	1	582018	
15	19/32	35	2 608 620 212	P1a	1	1	582025	
21	7/8	35	2 608 620 213	P1a	1	1	582032	
25	1	35	2 608 620 214	P1a	1	1	582049	
30	1 3/16	35	2 608 620 215	P1a	1	1	582056	
35	1 3/8	35	2 608 620 216	P1a	1	1	582063	

### Diamond router bit Best for Ceramic

best  Ceramic

Appropriate for GTR 18 V-LI and GTR 30 CE Professional.

Suitable for soft wall tiles through to hard floor tiles.

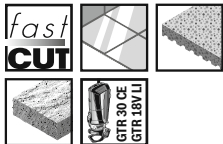

Product properties		Ordering information						
Shank mm	Shank Inch	Diameter (D) mm	Working length (L) mm	Part number	Packaging type	Sales package quantity	Despatch package quantity	Barcode 3165140...
6.35	1/4	7.2	35	2 608 620 217	P1a	1	1	582070

Order quantity for a part number in pieces = Sales package quantity x despatch package quantity  
 Order quantities that do not match the specified increments of the despatch package quantity (e.g. 5 -> 10 -> 15) are automatically rounded up to the next increment.

**Carbide router bit**



**Appropriate for** GTR 18 V-LI and GTR 30 CE Professional.  
**Suitable for** soft wall tiles.



Product properties				Ordering information				
Shank mm	Shank Inch	Diameter (D) mm	Working length (L) mm	Part number	Packaging type	Sales package quantity	Despatch package quantity	Barcode 3165140...
4	5/32	4	25	<b>2 608 620 218</b>	P1a	1	1	582087

**Accessories for diamond drill bits and router bits, carbide router bits**

Product properties		Ordering information					
Diameter mm	Diameter Inch	Part number	Packaging type	Sales package quantity	Despatch package quantity	Barcode 3165140...	

Collet

**Appropriate for** GTR 18 V-LI and GTR 30 CE Professional



4.0	5/32	<b>2 608 620 219</b>	PC1b	1	1	582094
-----	------	----------------------	------	---	---	--------



6.3	1/4	<b>2 608 620 220</b>	PC1b	1	1	582100
-----	-----	----------------------	------	---	---	--------



Dust extraction hose

**Appropriate for** GTR 30 CE Professional

35	1 3/8	<b>2 607 002 626</b>	C1a	1	1	582001
50	2					

Order quantity for a part number in pieces = Sales package quantity x despatch package quantity  
 Order quantities that do not match the specified increments of the despatch package quantity (e.g. 5 -> 10 -> 15) are automatically rounded up to the next increment.

# Diamond wet drill bits

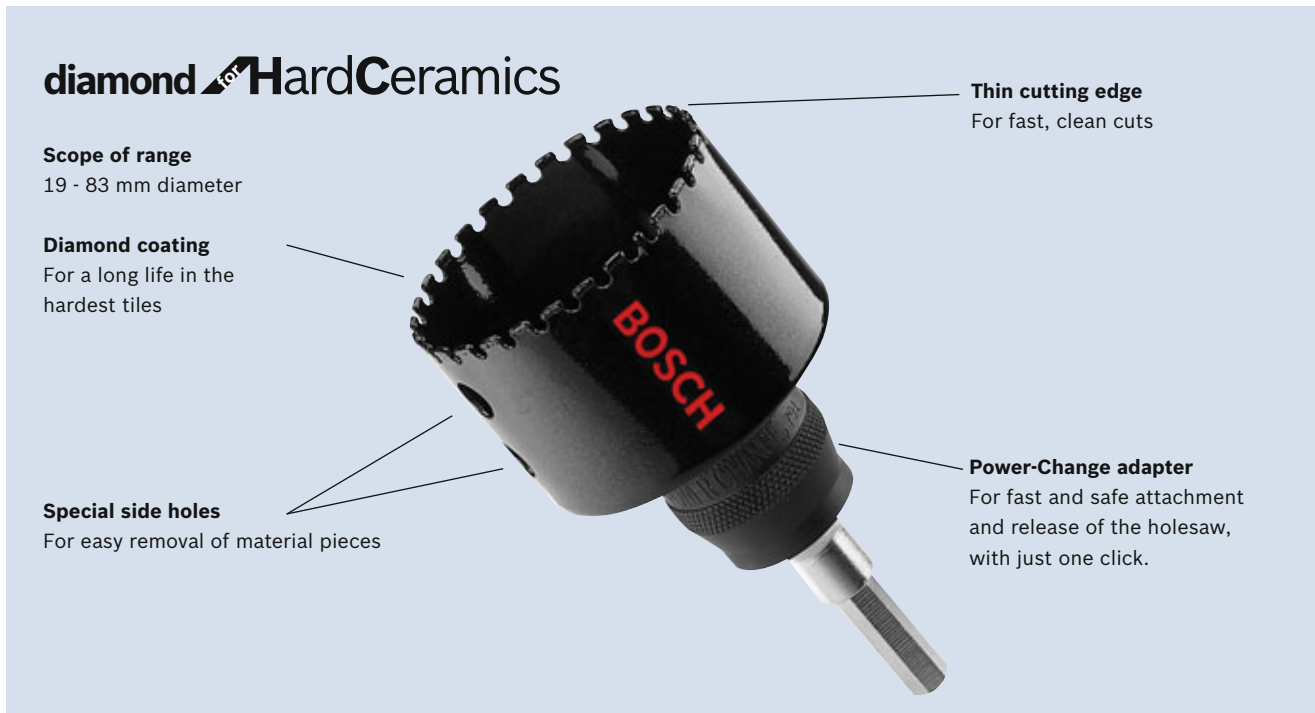

## Diamond holesaws for Hard Ceramics

diamond for HardCeramics

The cutting quality depends on the correct speed and the coolant used (see operating instructions).

**Suitable for** soft wall tiles through to very hard floor tiles such as fine stoneware; cylindrical shank.

**Note:** Drill without impact. Always work with water cooling. Only work with cordless drills.



Product properties	Diameter mm	Diameter Inch	Part number	Packaging type	Sales package quantity	Despatch package quantity	Barcode 3165140...
	19	3/4	2 608 580 301	PC1b	1	1	488990
	20	25/32	2 608 580 302	PC1b	1	1	489003
	22	7/8	2 608 580 303	PC1b	1	1	489010
	25	1	2 608 580 304	PC1b	1	1	489027
	29	1 1/8	2 608 580 305	PC1b	1	1	489034
	32	1 1/4	2 608 580 306	PC1b	1	1	489041
	35	1 3/8	2 608 580 307	PC1b	1	1	489058
	38	1 1/2	2 608 580 308	PC1b	1	1	489065
	41	1 5/8	2 608 580 394	PC1b	1	1	515160
	44	1 3/4	2 608 580 309	PC1b	1	1	489072
	51	2	2 608 580 310	PC1b	1	1	489089
	54	2 1/8	2 608 580 311	PC1b	1	1	489096
	57	2 1/4	2 608 580 312	PC1b	1	1	489102
	60	2 3/8	2 608 580 313	PC1b	1	1	489119
	64	2 1/2	2 608 580 314	PC1b	1	1	489126
	65	2 9/16	2 608 580 315	PC1b	1	1	489133
	67	2 5/8	2 608 580 316	PC1b	1	1	489157
	68	2 11/16	2 608 580 317	PC1b	1	1	489164

Order quantity for a part number in pieces = Sales package quantity x despatch package quantity  
Order quantities that do not match the specified increments of the despatch package quantity (e.g. 5 -> 10 -> 15) are automatically rounded up to the next increment.



**Diamond holesaws for Hard Ceramics**

Product properties		Ordering information				
Diameter mm	Diameter Inch	Part number	Packaging type	Sales package quantity	Despatch package quantity	Barcode 3165140...
70	2 3/4	2 608 580 318	PC1b	1	1	489171
76	3	2 608 580 319	PC1b	1	1	489188
79	3 1/8	2 608 580 320	PC1b	1	1	489195
83	3 1/4	2 608 580 321	PC1b	1	1	489201

**Diamond drill bits for Hard Ceramics**

**Suitable for** soft wall tiles through to very hard floor tiles such as fine stoneware.

**Note:** Drill without impact. Always work with water cooling. Only work with cordless drills.



Product properties		Ordering information				
Diameter (D) mm	Part number	Packaging type	Sales package quantity	Despatch package quantity	Barcode 3165140...	
5	2 608 550 605	P1a	1	1	495721	
6	2 608 550 606	P1a	1	1	495738	
7	2 608 550 607	P1a	1	1	495745	
8	2 608 550 608	P1a	1	1	495752	
10	2 608 550 609	P1a	1	1	495769	
12	2 608 550 610	P1a	1	1	495776	
14	2 608 550 611	P1a	1	1	495783	

**Accessories for diamond holesaws for Hard Ceramics**

Product properties		Ordering information				
Part number	Packaging type	Sales package quantity	Despatch package quantity	Barcode 3165140...		



Power-Change adapter with 8-mm hex shank. For holesaw diameter of 14-152 mm. Without pilot drill bit.

2 608 584 844	PC1b	1	1	429245
---------------	------	---	---	--------



Power-Change adapter Heavy Duty with 11-mm hex shank. For holesaw diameter of 14-152 mm. Without pilot drill bit.

2 608 580 095	PC1b	1	1	469500
---------------	------	---	---	--------



Power-Change adapter with SDS-plus shank. For holesaw diameter of 14-152 mm. Without pilot drill bit.

2 608 584 845	PC1b	1	1	429252
---------------	------	---	---	--------

Order quantity for a part number in pieces = Sales package quantity x despatch package quantity  
 Order quantities that do not match the specified increments of the despatch package quantity (e.g. 5 -> 10 -> 15) are automatically rounded up to the next increment.

**Robust Line diamond drill bit sets for Hard Ceramics**

**Suitable for** soft wall tiles through to very hard floor tiles such as fine stoneware.

**Note:** Drill without impact. Always work with water cooling. Only work with cordless drills.



Set size A:  
156.5 x 69.5 x 21.5 mm



Set size A:  
156.5 x 69.5 x 21.5 mm

Product properties		Ordering information				
Diameter mm	Part number	Packaging type	Sales package quantity	Despatch package quantity	Barcode 3165140...	
4-piece Robust Line diamond drill bit set						
6.0 8.0 10.0 14.0	2 607 019 880	P1k	4	1	495790	
5.0 6.0 7.0 8.0	2 607 019 881	P1k	4	1	495806	

**Accessories for diamond drill bits and diamond holesaws**



Product properties		Ordering information				
	Part number	Packaging type	Sales package quantity	Despatch package quantity	Barcode 3165140...	
Centring aid for diamond drill bits						
	2 608 598 142	PC1a	1	1	495813	



Centring aid for diamond drill bits and holesaws						
	2 608 580 327	C1a	1	1	489683	



Pressurised water bottle For water cooling of the diamond drill bits and holesaws Max. filling capacity 0.9 L Including hose (1.5 m long)						
	2 608 190 048	C1a	1	1	495820	

Order quantity for a part number in pieces = Sales package quantity x despatch package quantity  
Order quantities that do not match the specified increments of the despatch package quantity (e.g. 5 -> 10 -> 15) are automatically rounded up to the next increment.

# Diamond cutting discs

## FPP Extra-clean

**Scope of range:** 115 mm and 125 mm diameter

**Segmented cooling slots**

Enable less chips and, therefore, less risk of tile breakage compared to conventional, thicker diamond cutting discs for tiles

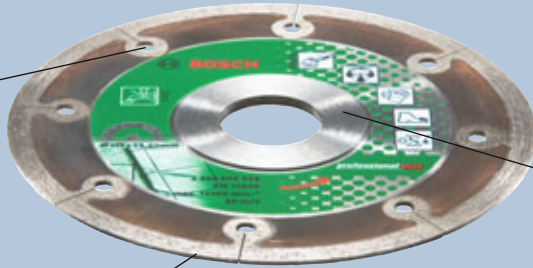

**Flange**

For more stability and less vibration.

**Extra-thin cutting edge of 1.2 mm**

For very clean and fine cuts in tiles. This removes the need for reworking and offers quick cutting with low resistance.

**Standard tile disc**

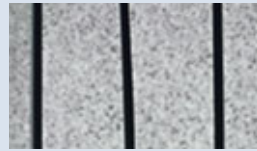

Normal cut > 1.6 mm

**Bosch FPP Extra-clean**

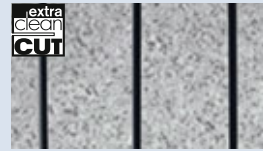

Fine, chip-free cut 1.2 mm

### Diamond cutting discs FPP Extra-clean

**professional plus**



The diamond cutting disc for the highest demands with regard to accurate, chip-free cuts. Exact cut edges and considerably less risk of tile breakage in all tiles.



Diameter mm	Bore diameter mm	Cutting width mm	Segment height mm	Part number	Packaging type	Sales package quantity	Despatch package quantity	Barcode 3165:140...
<b>Product properties</b>				<b>Ordering information</b>				
115	22.23	1.2	5	2 608 602 368	C1c	1	1	504997
125	22.23	1.2	5	2 608 602 369	C1c	1	1	505000

Order quantity for a part number in pieces = Sales package quantity x despatch package quantity  
 Order quantities that do not match the specified increments of the despatch package quantity (e.g. 5 -> 10 -> 15) are automatically rounded up to the next increment.

**Diamond cutting discs FPP Gres**

**professional plus**



The diamond cutting disc for the highest demands with regard to accurate, chip-free cuts in hard materials such as gres and extremely hard fine stoneware.



Product properties				Ordering information				
Diameter mm	Bore diameter mm	Cutting width mm	Segment height mm	Part number	Packaging type	Sales package quantity	Despatch package quantity	Barcode 3165140...
115	22.23	1.4	7	<b>2 608 602 478</b>	C1c	1	1	518086
125	22.23	1.4	7	<b>2 608 602 479</b>	C1c	1	1	518093

**Diamond cutting discs FPP**

**professional plus**

The right disc for the highest demands on lifetime. Good cut quality without broken edges, even in extra-hard fine stone slabs.

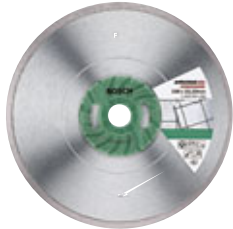

Product properties				Ordering information				
Diameter mm	Bore diameter mm	Cutting width mm	Segment height mm	Part number	Packaging type	Sales package quantity	Despatch package quantity	Barcode 3165140...
110	22.23	1.6	8	<b>2 608 600 183</b>	C1c	1	1	110983
115	22.23	1.6	8	<b>2 608 600 184</b>	C1c	1	1	110990
125	22.23	1.6	8	<b>2 608 600 185</b>	C1c	1	1	111003
150	22.23	1.6	8	<b>2 608 600 186</b>	C1c	1	1	111010
180	22.23	1.8	8	<b>2 608 600 187</b>	C1c	1	1	111027
230	22.23	1.8	8	<b>2 608 600 188</b>	C1c	1	1	111034



180	25.40	1.5	8	<b>2 608 602 209</b>	C1c	1	1	441377
200	25.40	1.5	8	<b>2 608 602 208</b>	C1c	1	1	441360
230	25.40	1.8	8	<b>2 608 602 419</b>	C1c	1	1	511957
250	25.40	2.0	8	<b>2 608 602 420</b>	C1c	1	1	511964
300	25.40	2.0	8	<b>2 608 600 750</b>	C1a	1	1	277884
350	25.40	2.0	8	<b>2 608 600 751</b>	C1a	1	1	277891



**Appropriate for** Cordless Angle Grinder GWS 14,4 V Professional With SDS-pro fitting

100	22.23	1.6	8	<b>2 608 600 856</b>	C1c	1	1	293396
-----	-------	-----	---	----------------------	-----	---	---	--------

Order quantity for a part number in pieces = Sales package quantity x despatch package quantity  
 Order quantities that do not match the specified increments of the despatch package quantity (e.g. 5 -> 10 -> 15) are automatically rounded up to the next increment.



**Diamond cutting discs FPE****professional eco**

For clean cut edges in ceramic tiles. The low-cost solution for all-round use.



	Diameter mm	Bore diameter mm	Cutting width mm	Segment height mm	Part number	Packaging type	Sales package quantity	Despatch package quantity	Barcode 3165140...
<b>Product properties</b>					<b>Ordering information</b>				
<b>110</b>	22.23	1.6	5	<b>2 608 600 437</b>	C1c	1	1	197007	
<b>115</b>	22.23	1.7	5	<b>2 608 602 201</b>	C1c	1	1	441292	
<b>125</b>	22.23	1.7	5	<b>2 608 602 202</b>	C1c	1	1	441308	
<b>150</b>	22.23	1.9	5	<b>2 608 602 203</b>	C1c	1	1	441315	
<b>180</b>	22.23	2.2	5	<b>2 608 602 204</b>	C1c	1	1	441311	
<b>230</b>	22.23	2.4	5	<b>2 608 602 205</b>	C1c	1	1	441339	
<b>180</b>	25.40	1.6	5	<b>2 608 602 211</b>	C1c	1	1	441391	
<b>200</b>	25.40	1.6	5	<b>2 608 602 210</b>	C1c	1	1	441384	
<b>230</b>	25.40	1.9	5	<b>2 608 602 421</b>	C1c	1	1	511971	
<b>250</b>	25.40	1.9	5	<b>2 608 602 422</b>	C1c	1	1	511988	
<b>300</b>	25.40	2.0	5	<b>2 608 600 755</b>	C1a	1	1	277938	
<b>350</b>	25.40	2.0	5	<b>2 608 600 756</b>	C1a	1	1	277945	

**Accessories for working with diamond cutting discs**

	Diameter mm	Diameter mm	Part number	Packaging type	Sales package quantity	Despatch package quantity	Barcode 3165140...
<b>Product properties</b>			<b>Ordering information</b>				
Locking flange for clamping 300 mm diameter discs <b>Appropriate for</b> Slot Cutter GSF 100 A (0 601 367...); Special Cut-Off Grinders (0 601 364...); GWS 24-300; GWS 24-300 J Professional	-	<b>100</b>	<b>2 605 703 016</b>	P0b	1	1	056816
Locking flange for special cut-off grinders 0 601 364 ... for clamping 300 mm diameter discs <b>Appropriate for</b> Slot Cutter GSF 100 A (0 601 367...); GWS 24-300; GWS 24-300 J Professional	-	<b>100</b>	<b>2 605 703 017</b>	P0b	1	1	056823
Flange sets for clamping 300 mm diameter discs <b>Appropriate for</b> Slot Cutter GSF 100 A (0 601 367...); GWS 24-300; GWS 24-300 J Professional	-	-	<b>2 603 345 003</b>	P0b	1	1	056809
Parallel guide <b>Appropriate for</b> GNF 20 CA Professional	-	-	<b>3 607 000 060</b>	P0b	1	1	018654

Order quantity for a part number in pieces = Sales package quantity x despatch package quantity  
Order quantities that do not match the specified increments of the despatch package quantity (e.g. 5 -> 10 -> 15) are automatically rounded up to the next increment.

# Accessories for work safety

## Protective goggles



Product properties	Tested to	Part number	Packaging type	Sales package quantity	Despatch package quantity	Barcode 3165140...
Full protection goggles With indirect ventilation and mist-free, colourless plastic lens. Protect against strong knocks, large dust particles and liquid. Also suitable for spectacle wearers.	EN 166	2 607 990 037	P1d	1	1	093668



Protective goggles Fully transparent, can be worn over glasses.	EN 166	2 607 990 041	P1d	1	1	093705
--	--------	---------------	-----	---	---	--------

## Protective masks



Product properties	Tested to	Part number	Packaging type	Sales package quantity	Despatch package quantity	Barcode 3165140...
Fine dust mask Protects against non-toxic fine dust, for use by do-it-yourselfers, for work such as drilling, chiselling and cutting. Unsuitable protection against poisonous gases and vapours!	EN 149 FF P1	2 607 990 032	P1d	2	1	093613



Fine dust mask Protects against low level poisonous particles, fine dust, grinding dust when sanding wood and concrete; e.g. dust from sanding paint. Same as class FF P1 but with a higher degree of protection.	EN 149 FF P2	2 607 990 034	P1d	2	1	093637
--	--------------	---------------	-----	---	---	--------



Fine dust/odour mask For low level poisonous particles, foul organic smells and particles (paint spray mask). With exhalation valve for easier breathing. With integrated activated charcoal filter for reduction of smells.	EN 149 FF P2	2 607 990 036	P1d	2	1	093651
---	--------------	---------------	-----	---	---	--------

Order quantity for a part number in pieces = Sales package quantity x despatch package quantity  
Order quantities that do not match the specified increments of the despatch package quantity (e.g. 5 -> 10 -> 15) are automatically rounded up to the next increment.

## Ear protectors

Product properties	Ordering information
	Tested to Part number Packaging type Sales package quantity Despatch quantity Barcode 3165140...



Ear protectors  
 Soundproofing level 19 dB (A)  
 Adjustable plastic bar. All parts washable. L rate 14 dB, M rate 20 dB, H rate 27 dB,  
 SNR rate 23 dB

EN 352	2 607 990 042	P1d	1	1	093712
--------	---------------	-----	---	---	--------



Ear protectors  
 Soundproofing level 24 dB (A)  
 Folding, padded, adjustable head bar. L rate 17 dB, M rate 25 dB, H rate 32 dB,  
 SNR rate 28 dB

EN 352	2 607 990 043	P1d	1	1	093729
--------	---------------	-----	---	---	--------



Ear plugs  
 In plastic box. L rate 31 dB, M rate 32 dB, H rate 32 dB, SNR rate 34 dB

EN 352	2 607 990 044	P1d	10	1	093736
--------	---------------	-----	----	---	--------

## Protective gloves

Hands also need to be protected, e.g. stones can become missiles during breaking work.

Product properties	Ordering information
	Part number Packaging type Sales package quantity Despatch quantity Barcode 3165140...



Protective gloves  
 Made of grey cowhide leather, leather thickness 1.2 mm, back of hand made of twisted cotton,  
 finger nail, wrist and pulse protection, sewn-in rubber insert, plastic-coated twisted sleeve,  
 inside palm lining, length 26 cm, men standard size 10.

	2 607 000 134	P1d	1	1	017954
--	---------------	-----	---	---	--------



**Robert Bosch**  
15th Road, Randjespark  
Privat Bag X118  
Midrand, 1685  
Phone: (011) 651 9600  
Fax: (011) 651 9881 (Sales)  
(011) 651 9880 (Marketing)



**BOSCH**  
Invented for life